

# win **TURK**

PVC KAPI VE PENCERE SİSTEMLERİ

*Kalitesi ve  
konforuyla  
her mevsim  
yanınızda...*



YENİ DİZAYN

**Minaserisi**  
60'LİK 3 ODACIKLI SİSTEM

**Miraserisi**  
60'LİK 4 ODACIKLI SİSTEM

**Vegaserisi**  
70/60 5 ODACIKLI SİSTEM

**Orionserisi**  
70'LİK 5 ODACIKLI SİSTEM

**Atlasserisi**  
80'LİK 6 ODACIKLI SİSTEM

**Sürme serisi**

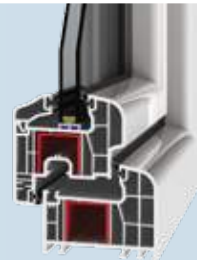
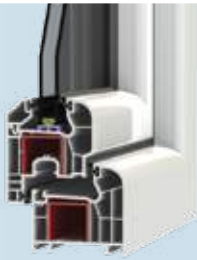



 Pvc kapı ve pencere sistemleri sektöründe faaliyet göstermek üzere 1994 yılında kurulan ERAY PLASTİK halen Eskişehir Organize Sanayi Bölgesinde 15.000 m<sup>2</sup> alan üzerinde **winTURK** markası ile üretimini devam ettirmektedir.

Firmamız dünya standartlarında yüksek kalite ve estetiğe sahip ürünlerini kendi ARGE çalışmalarıyla geliştirmiştir. Üretimde kullanılan hatlar, Avrupa'nın en iyileri kabul edilen Alman Krausmaffeı ve Avusturya Greinner PVC ekstrüzyon makinalarıdır.

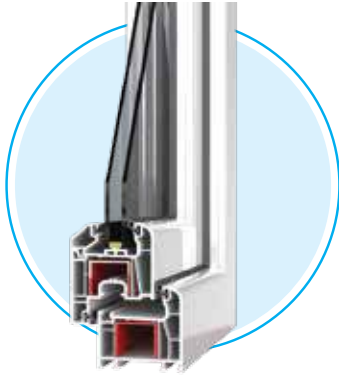
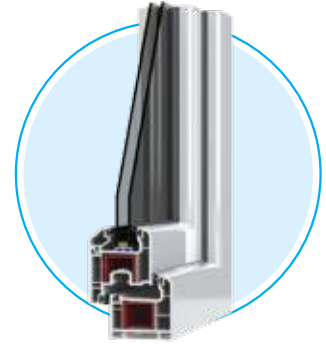

 ERAY PLASTİK, established in 1994 to perform business in PVC door and window systems industry, is currently continue its production on 15.000 m<sup>2</sup> area in Eskişehir Organized Industrial District with the brand name **winTURK**.

Our firm has developed its high quality and aesthetical products in world standards by its own research and development studies. The lines used in production are Krausmaffeı (German) and Greinner (Austria) PVC extrusion machines that have been recognized as the best of Europe.

**winTURK**

*PVC Kapı ve Pencere Sistemleri her türlü mimari yapıya ve aksesuara uyum sağlayabilecek şekilde dizayn edilmiştir.*





> Modern yaşam alanları için dizayn edilmiş, ses ve ısı yalıtımı sağlayan

**Minaserisi**  
60'LİK 3 ODACIKLI SİSTEM

**Miraserisi**  
60'LİK 4 ODACIKLI SİSTEM

**Vegaserisi**  
70/60 5 ODACIKLI SİSTEM

**Orionserisi**  
70'LİK 5 ODACIKLI SİSTEM

**Atlasserisi**  
80'LİK 6 ODACIKLI SİSTEM

**Sürmeseri**

- > Toz ve kir tutmayı önleyen, estetik görünüm sağlayan oval yüzey
- > Su tahliyesi sağlayan eğimli yüzey
- > Kendinden gri contalı profiller
- > Parlak ve pürüzsüz yüzeyler
- > Tek tırnak çıta yuvası ile kolay cam montajı
- > Kendinden contalı dekoratif çitalar
- > 4 mm tek cam , 4+12+4=20 mm, 4+12+4=24 mm çift cam ve 4+9+4+9+4=30 mm, 4+10+4+10+4=32 mm üç cam uygulama seçenekleri
- > Yüksek mukavemetli, sıcak daldırma, galvanizli tek tip çelik destek sacı
- > Ahşap desenli renk seçenekleri
- > Uzun ömürlü ve her türlü iklim şartına uyumlu

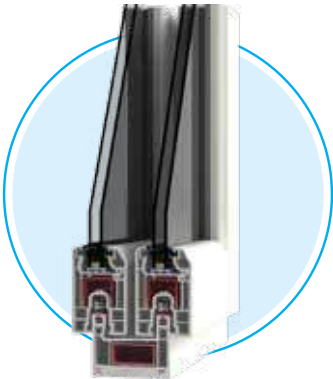
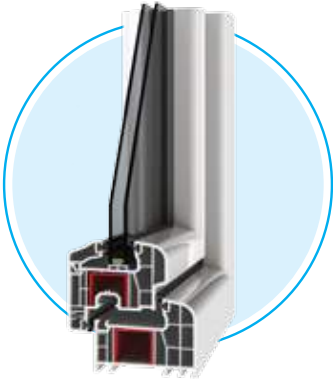
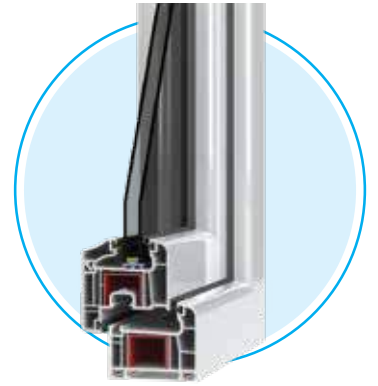
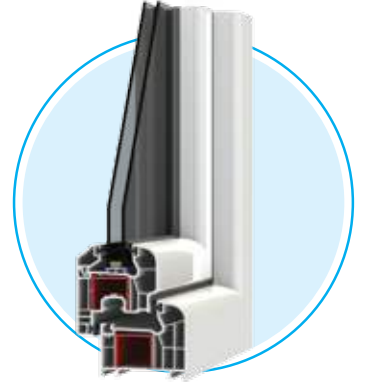

> Systems designed for modern living spaces, sound and heat insulation

**Minaserisi**  
60'LİK 3 ODACIKLI SİSTEM

**Miraserisi**  
60'LİK 4 ODACIKLI SİSTEM

**Vegaserisi**  
70/60 5 ODACIKLI SİSTEM

**Orionserisi**  
70'LİK 5 ODACIKLI SİSTEM

**Atlasserisi**  
80'LİK 6 ODACIKLI SİSTEM

**Sürmeseri**

- > To keep dust and dirt, preventing the oval surface that provides an aesthetic appearance
- > Sloping surface that allows water drainage
- > Profiles with gray seal
- > Bright and smooth surfaces
- > Easy fit glass with one leg glass bead
- > Decorative glass bead with gaskets seal
- > 4 mm single glass, 4 +12 +4 = 20 mm, 4 +12 +4 = 24 mm double glazing and 4 +9 +4 +9 +4 = 30 mm, 4 +10 +4 +10 +4 = 32 mm three glass application options
- > High strength, hot dipping, galvanized one type steel support plate
- > Laminated color options
- > Long-lasting and compatible with all kinds of weather condition



## Miraserisi

60'LIK 4 ODACIKLI SİSTEM

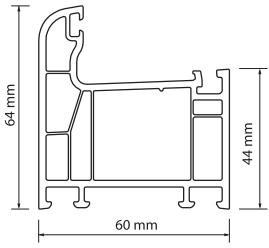

### W 6410

**Kasa Profili / Frame Profile**  
Ağırlık / Weight : 0.970 kg / mt

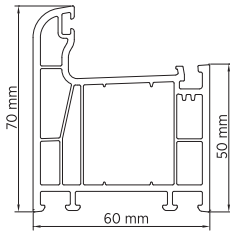

### W 6410 S

**Süper Kasa Profili**  
*Super Frame Profile*  
Ağırlık / Weight : 1.110 kg / mt

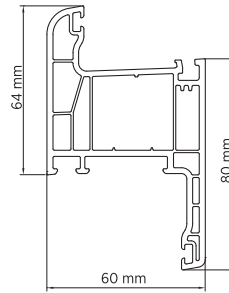

### W 6410 P

**Pervazlı Kasa Profili**  
*Border Frame Profile*  
Ağırlık / Weight : 1.260 kg / mt

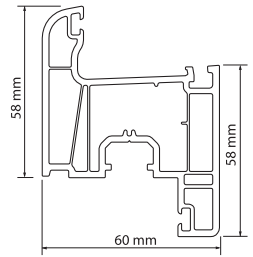

### W 6420

**Kanat Profili / Sash Profile**  
Ağırlık / Weight : 1.130 kg / mt

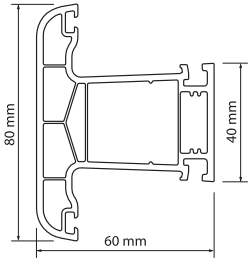

### W 6430

**Orta Kayıt Profili**  
*Mullion Profile*  
Ağırlık / Weight : 1.050 kg / mt

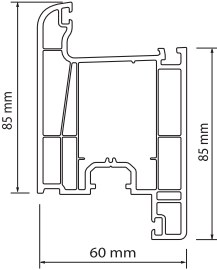

### W 6440

**Kapı Kanat Profili**  
*Door Sash Profile*  
Ağırlık / Weight : 1.450 kg / mt

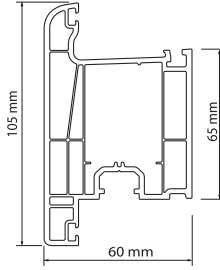

### W 6450

**Dışa Açılan Kapı Kanat Profili**  
*Reverse Door Sash Profile*  
Ağırlık / Weight : 1.450 kg / mt

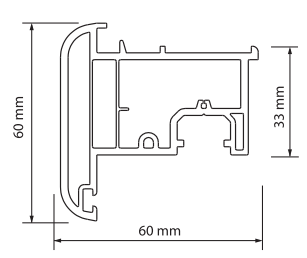

### W 6460

**Hareketli Orta Kayıt Profili**  
*Moveable Mullion Profile*  
Ağırlık / Weight : 0.925 kg / mt

## Minaserisi

60'LIK 3 ODACIKLI SİSTEM

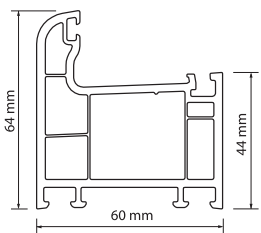

### W 6310

**Kasa Profili / Frame Profile**  
Ağırlık / Weight : 0.900 kg / mt

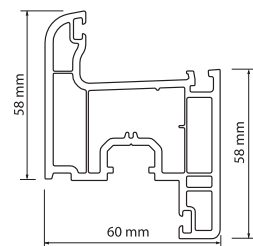

### W 6320

**Kanat Profili / Sash Profile**  
Ağırlık / Weight : 1.050 kg / mt

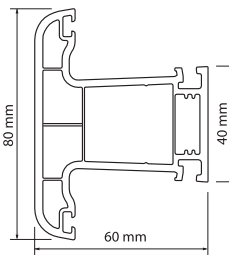

### W 6330

**Orta Kayıt Profili / Mullion Profile**  
Ağırlık / Weight : 0.950 kg / mt

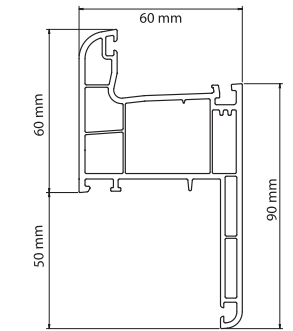

### W 6310P

**Pervazlı Kasa Profili**  
*Border Frame Profile*  
Ağırlık / Weight : 1.260 kg / mt

## Ortak Çıtalar

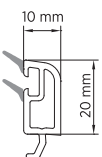

### S 006

**Üç Cam Çıtası (30 mm)**  
*Three Glass Bead (30 mm)*  
Ağırlık / Weight : 0.185 kg / mt

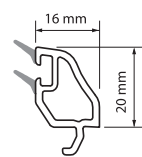

### W 6470

**Çift Cam Çıtası (24 mm)**  
*Double Glass Bead (24 mm)*  
Ağırlık / Weight : 0.190 kg / mt

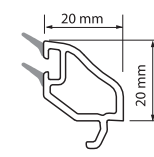

### W 6480

**Çift Cam Çıtası (20 mm)**  
*Double Glass Bead (20 mm)*  
Ağırlık / Weight : 0.200 kg / mt

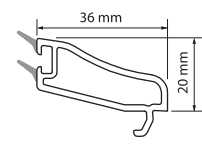

### W 6490

**Tek Cam Çıtası (4 mm)**  
*Single Glass Bead (4 mm)*  
Ağırlık / Weight : 0.270 kg / mt

## Orionserisi

70'LİK 5 ODACIKLI SİSTEM

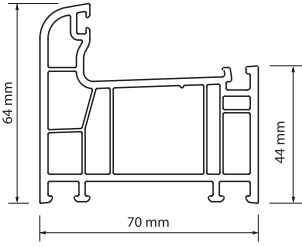

**W 7010**  
Kasa Profili / Frame Profile  
Ağırlık / Weight: 1.160 kg / mt

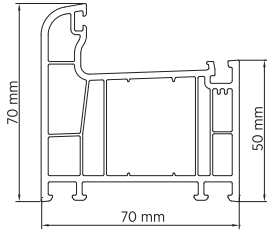

**W 7010 S**  
Süper Kasa Profili  
Super Frame Profile  
Ağırlık / Weight: 1.230 kg / mt

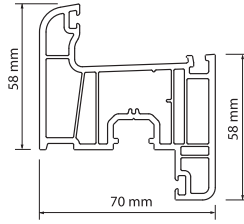

**W 7020**  
Kanat Profili / Sash Profile  
Ağırlık / Weight: 1.300 kg / mt

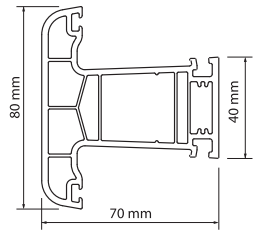

**W 7030**  
Orta Kayıt Profili  
Mullion Profile  
Ağırlık / Weight: 1.250 kg / mt

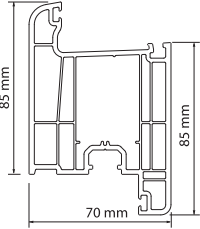

**W 7040**  
Kapı Kanat Profili  
Door Sash Profile  
Ağırlık / Weight: 1.700 kg / mt

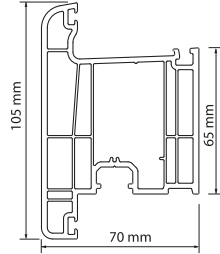

**W 7050**  
Dışa Açılan Kapı Kanat Profili  
Reverse Door Sash  
Ağırlık / Weight: 1.700 kg / mt

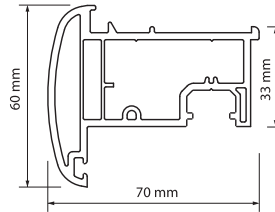

**W 7060**  
Hareketli Orta Kayıt Profili  
Moveable Mullion Profile  
Ağırlık / Weight: 0.980 kg / mt

## Atlasserisi

80'LİK 6 ODACIKLI SİSTEM

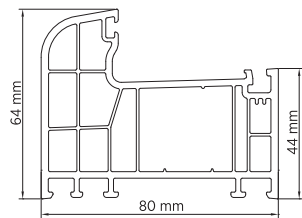

**W 8010**  
Kasa Profili / Frame Profile  
Ağırlık / Weight: 1.310 kg / mt

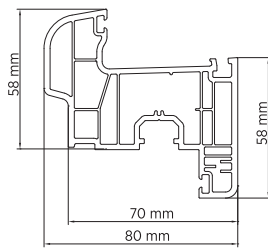

**W 8020**  
Damlalıklı Kanat Profili  
Self Drainage Sash Profile  
Ağırlık / Weight: 1.400 kg / mt

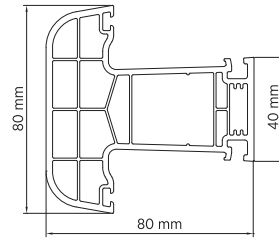

**W 8030**  
Orta Kayıt Profili / Mullion Profile  
Ağırlık / Weight: 1.420 kg / mt

## Ortak Çıtalar

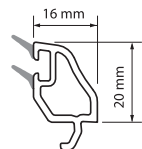

**W 6470**  
Üç Cam Çıtası (32 mm)  
Three Glass Bead (32 mm)  
Ağırlık / Weight: 0.180 kg / mt

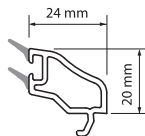

**W 7070**  
Çift Cam Çıtası (24 mm)  
Double Glass Bead (24 mm)  
Ağırlık / Weight: 0.225 kg / mt

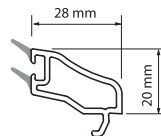

**W 7080**  
Çift Cam Çıtası (20 mm)  
Double Glass Bead (20 mm)  
Ağırlık / Weight: 0.240 kg / mt

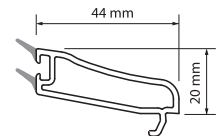

**W 7090**  
Tek Cam Çıtası (4 mm)  
Single Glass Bead (4 mm)  
Ağırlık / Weight: 0.310 kg / mt

**Vegä**serisi  
70/60 5 ODACIKLI SİSTEM

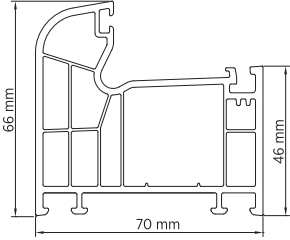

**V 7610**

**Kasa Profili / Frame Profile**  
Ağırlık / Weight: 1.100 kg / mt

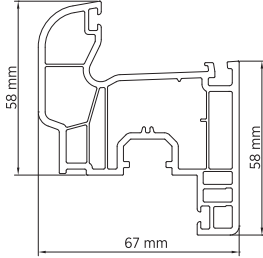

**V 7620**

**Damlalıklı Kanat Profili**  
Self Drainage Sash Profile  
Ağırlık / Weight: 1.170 kg / mt

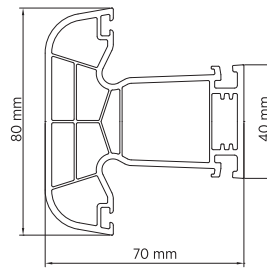

**V 7630**

**Orta Kayıt Profili**  
Mullion Profile  
Ağırlık / Weight: 1.250 kg / mt

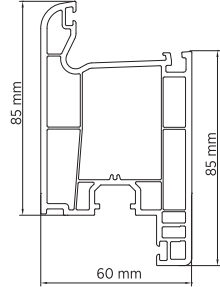

**V 6440**

**Kapı Kanat Profili**  
Door Sash Profile  
Ağırlık / Weight: 1.430 kg / mt

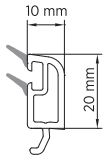

**S 006**

**Üç Cam Çıtası (30 mm)**  
Three Glass Bead (30 mm)  
Ağırlık / Weight: 0.185 kg / mt

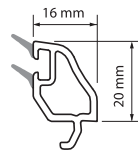

**W 6470**

**Çift Cam Çıtası (24 mm)**  
Double Glass Bead (24 mm)  
Ağırlık / Weight: 0.190 kg / mt

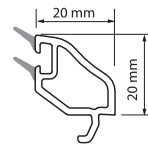

**W 6480**

**Çift Cam Çıtası (20 mm)**  
Double Glass Bead (20 mm)  
Ağırlık / Weight: 0.200 kg / mt

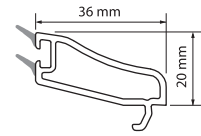

**W 6490**

**Tek Cam Çıtası (4 mm)**  
Single Glass Bead (4 mm)  
Ağırlık / Weight: 0.270 kg / mt

**Sürme**serisi

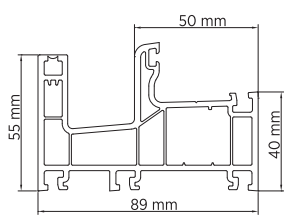

**S 001**

**Sürme Tek Raylı Kasa**  
Fixed Sliding Door Frame Profile  
Ağırlık / Weight: 1.470 kg / mt

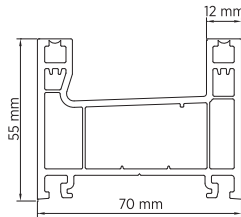

**S 002**

**Sürme Çift Raylı Kasa**  
Fixed Sliding Door Frame Profile  
Ağırlık / Weight: 1.150 kg / mt

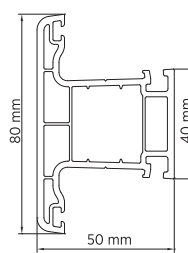

**S 003**

**Sürme Orta Kayıt Profili**  
Sliding Mullion Profile  
Ağırlık / Weight: 1.010 kg / mt

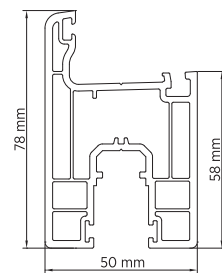

**S 004**

**Sürme Kanat**  
Sliding Sash Profile  
Ağırlık / Weight: 1.240 kg / mt

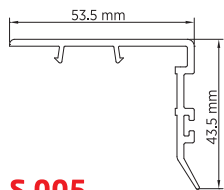

**S 005**

**Sürme Kanat Kapama**  
Sliding Door Sash Profile  
Ağırlık / Weight: 0.320 kg / mt

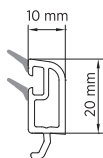

**S 006**

**Sürme Çift Cam Çıtası (24 mm)**  
Sliding Double Glass Bead (24 mm)  
Ağırlık / Weight: 0.183 kg / mt

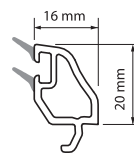

**W 6470**

**Çift Cam Çıtası (18-20 mm)**  
Double Glass Bead (18-20 mm)  
Ağırlık / Weight: 0.186 kg / mt

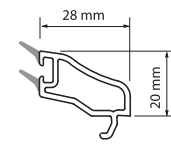

**W 7080**

**Tek Cam Çıtası (4 mm)**  
Single Glass Bead (4 mm)  
Ağırlık / Weight: 0.240 kg / mt

## Yardımcı Profiller

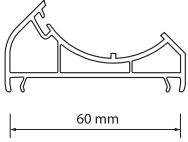

**W 6520**  
60 mm Köşe Dönüş Adaptörü  
60 mm Corner Turning Adapter  
Ağırlık / Weight : 0.520 kg / mt

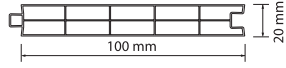

**W 6530**  
100 mm Panel Profili  
100 mm Panel Profile  
Ağırlık / Weight : 0.560 kg / mt

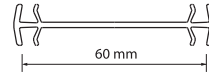

**W 6540**  
60 mm İnce Bağ Profili  
60 mm Coupling Profile  
Ağırlık / Weight : 0.265 kg / mt

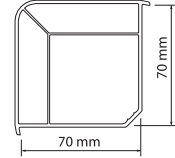

**W 7100**  
70x70 Kutu Profili  
70x70 Corner Profile  
Ağırlık / Weight : 0.980 kg / mt

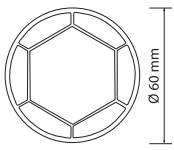

**W 7110**  
Köşe Dönüş Borusu  
Corner Turning Pipe  
Ağırlık / Weight : 0.745 kg / mt

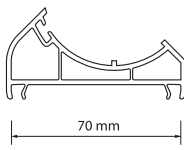

**W 7120**  
70 mm Köşe Dönüş Adaptörü  
70 mm Corner Turning Adapter  
Ağırlık / Weight : 0.605 kg / mt

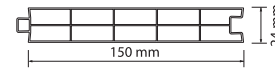

**W 7130**  
150 mm Panel Profili  
150 mm Panel Profile  
Ağırlık / Weight : 0.790 kg / mt

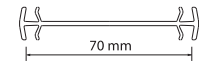

**W 7140**  
70 mm İnce Bağ Profili  
70 mm Coupling Profile  
Ağırlık / Weight : 0.295 kg / mt

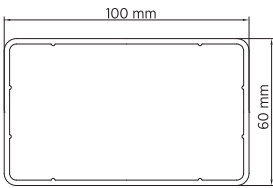

**W 9010**  
100 x 60 Kutu Profili  
100x60 Corner Profile  
Ağırlık / Weight : 0.990 kg / mt

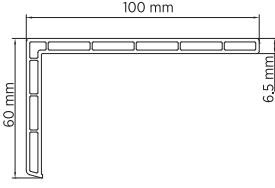

**W 9020**  
Pervaz Profili  
Sill Joint Extension Profile  
Ağırlık / Weight : 0.720 kg / mt

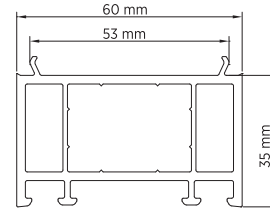

**W 9060**  
60 mm Kasa Yükseltme Profili  
60 mm Frame Extension Profile  
Ağırlık / Weight : 0.760 kg / mt

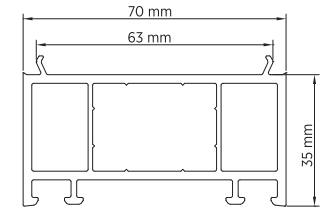

**W 9070**  
70 mm Kasa Yükseltme Profili  
70 mm Frame Extension Profile  
Ağırlık / Weight : 0.830 kg / mt

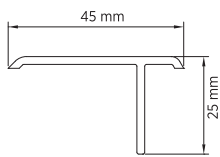

**W 9040**  
T Kapama  
Asymmetrical T  
Ağırlık / Weight : 0.200 kg / mt

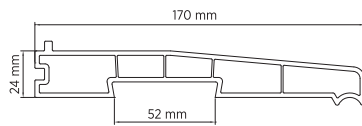

**W 9000**  
Denizlik Profili  
Outer Sill Profile  
Ağırlık / Weight : 1.450 kg / mt

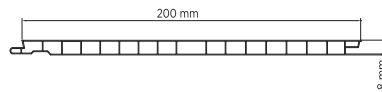

**W 9030**  
Tavan Lambri  
Flat PVC Panel  
Ağırlık / Weight : 0.370 kg / mt

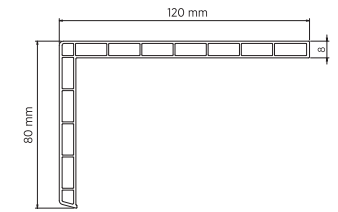

**W 9050**  
Pervaz Profili  
Sill Joint Extension Profile  
Ağırlık / Weight : 0.820 kg / mt



## Alyaserisi

60'LIK 4 ODACIKLI SİSTEM

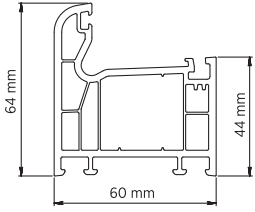

### V 6610

#### Kasa Profili

Frame Profile

Ağırlık / Weight : 1.110 kg / mt

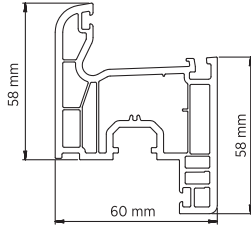

### V 6620

#### Kanat Profili

Sash Profile

Ağırlık / Weight : 1.280 kg / mt

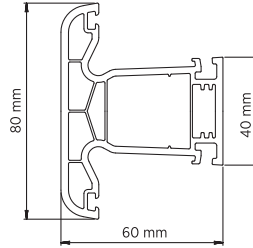

### V 6630

#### Orta Kayıt Profili

Mullion Profile

Ağırlık / Weight : 1.220 kg / mt

## Alternatif Çıtalar

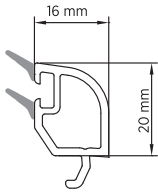

### V 6470

#### Çift Cam Çıtası (24 mm)

Double Glass Bead (24 mm)

Ağırlık / Weight : 0.180 kg / mt

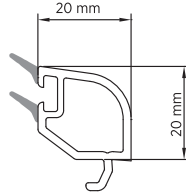

### V 6480

#### Çift Cam Çıtası (20 mm)

Double Glass Bead (20 mm)

Ağırlık / Weight : 0.190 kg / mt

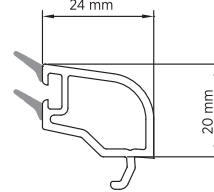

### V 7070

#### Çift Cam Çıtası (24 mm)

Double Glass Bead (24 mm)

Ağırlık / Weight : 0.210 kg / mt

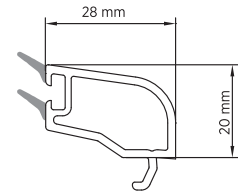

### V 7080

#### Çift Cam Çıtası (20 mm)

Double Glass Bead (20 mm)

Ağırlık / Weight : 0.220 kg / mt

## Destek Sac Detayları

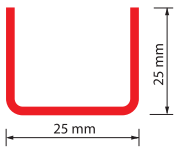

### DS 001

#### Kasa / Kanat / Orta Kayıt Destek Sacı

Frame / Sash / Mullion Steel

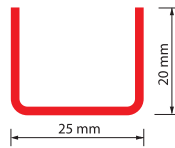

### DS 002

#### Sürme Çiftli Kasa Destek Sacı

Sliding Double Frame Steel

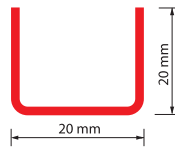

### DS 003

#### Sürme Tekli Kasa Destek Sacı

Sliding Single Frame Steel

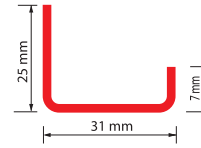

### DS 004

#### Kanat Özel Sacı

Sash Special Steel

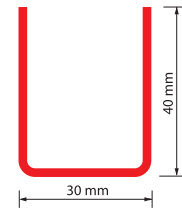

### DS 005

#### Kapı / Dışa Açılan Kapı Sacı

Door / Reverse Door Steel

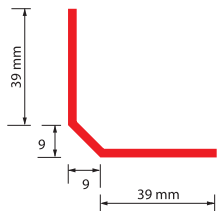

### DS 006

#### 70 x 70 Kutu Sacı

70 x 70 Corner Steel

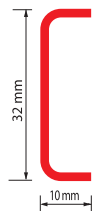

### DS 007

#### 60 mm Hareketli Orta Kayıt Sacı

60 mm Moveable Mullion Steel

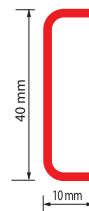

### DS 008

#### 70 mm Hareketli Orta Kayıt Sacı

70 mm Moveable Mullion Steel

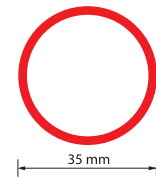

### DS 009

#### Köşe Dönüş Boru Sacı

Corner Turning Pipe Steel



 Kuruluşundan itibaren kaliteli üretim politikasını belirleyen firmamız tercih ettiği hammaddelerle, TSE ve ISO 9001 sistemlerine uygun üretim yapmaktadır.

Çağdaş teknoloji ile Türk Mühendis ve işçiliğini birleştirerek kalıcı müşteri memnuniyetini sağlamak temel ilkemizdir.

**winTURK** olarak gerek üretim aşamasında gerek satış ve pazarlama aşamalarında hizmeti ticari kaygıların üstünde tutmaktadır.



*Açtığımız pencerenin size huzur getirmesi dileği ile...*



 Determining quality production policy since the establishment and by preferring raw materials, our firm make productions appropriate to TSE and ISO 9001 systems.

Our primary principle is to provide permanent client satisfaction by combining Turkish engineer and workforce with modern technology.

As **winTURK**, the service comes in front of our trading concerns in both production and sales and marketing stages.



## Lamine Kaplama



 **winTURK** fabrika stoğunda katalogta görünen lamine kaplama çeşitlerini sürekli bulundurmaktadır. Lamine kaplamalar bütün serilerde uygulanmaktadır.



You can find at the catalogue the types of lamine, to be found in **winTURK** store everytime. These lamine plates are used in all series of our company.

*altın meşe*



*maun*



*koyu meşe*



## Lamine Kaplama



### Lamine Kaplama Örneklerimiz

*altın meşe*



*maun*



*koyu meşe*



*Pencerelerinize ahşabın değerini ve güzelliğini katmak için...*

- Zengin renk seçenekleri sayesinde dekorasyonunuza uygun,
- Ahşap görünümü sayesinde doğa dostu,
- Ahşap doğramalar gibi bakım ve boya gerektirmez.



Garantilidir  
Guaranteed



Yeşili ve Çevreyi Korur  
Protects Green and Environment

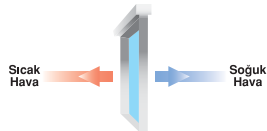

Sıcak ve Soğuk Havalara Dayanıklı  
Resistant to Hot and Cold Weathers



%100 Yeniden Dönüşümlü  
100% Recycled



Zehirli Madde İçermez  
Does not contain any poisonous materials



Bakım ve Boya Gerektirmez  
No need for Care and Painting

# Sandwich Panel

## SANDWICH PANEL

- Montajı kolay,
- Mukavemeti yüksek,
- Altınmeşe ve maun folyo ile kaplanabilir,
- Hafif olması sebebiyle taşınması ve nakliyesi kolaydır.
- UV dayanımı yüksek olduğu için uzun ömürlüdür.
- Ses ve ısı izolasyonu sağlar.
- Geri dönüşümlüdür.

## Sandwich Panel Örnekleri

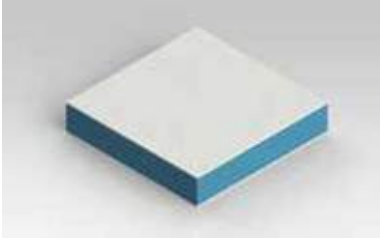

**P 1020**  
BEYAZ SANDWICH PANEL ( 20 mm )  
WHITE SANDWICH PANEL ( 20 mm )

**P 1024**  
BEYAZ SANDWICH PANEL ( 24 mm )  
WHITE SANDWICH PANEL ( 24 mm )

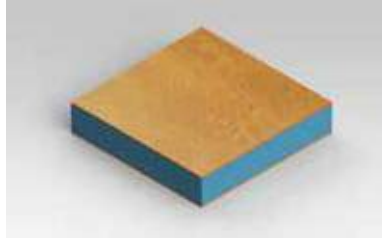

**P 1020CA**  
ALTINMEŞE SANDWICH PANEL ( 20 mm )  
GOLDENOAK SANDWICH PANEL ( 20 mm )

**P 1024CA**  
ALTINMEŞE SANDWICH PANEL ( 24 mm )  
GOLDENOAK SANDWICH PANEL ( 24 mm )

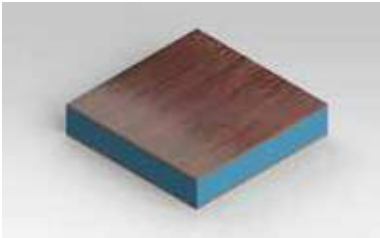

**P 1020CM**  
MAUN SANDWICH PANEL ( 20 mm )  
MAUN SANDWICH PANEL ( 20 mm )

**P 1024CM**  
MAUN SANDWICH PANEL ( 24 mm )  
MAUN SANDWICH PANEL ( 24 mm )

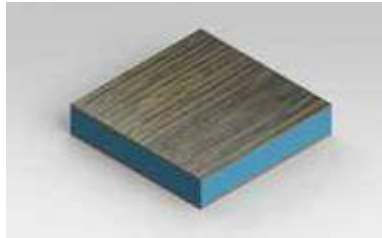

**P 1020CK**  
KOYU MEŞE SANDWICH PANEL ( 20 mm )  
DARKOAK SANDWICH PANEL ( 20 mm )

**P 1024CK**  
KOYU MEŞE SANDWICH PANEL ( 24 mm )  
DARKOAK SANDWICH PANEL ( 24 mm )



## PVC Levha



PVC esaslı levhalar 0,70 mm'den 3,00 mm kalınlığa ve 500 mm'den 2000 mm genişliğe kadar üretilmektedir.

- Yüksek UV dayanımı vardır.
- Darbe direnci yüksektir.
- Suya karşı dayanıklıdır.
- Isı iletkenliği düşüktür.
- Isı izolasyonu yüksektir.
- Ses izolasyonu yüksektir.
- Thermoform sayesinde çok basit şekillendirilebilir.

Genel olarak Sandwich Panel yapımında, PVC kapılarda ve hijyen gerektiren gıda sektöründe kaplama malzemesi olarak kullanılmaktadır.

### *Kaplamalı levhalarda*

- *Altınmeşe*
- *Maun*
- *Koyumeşe*

*Uygulamamız mevcuttur.*

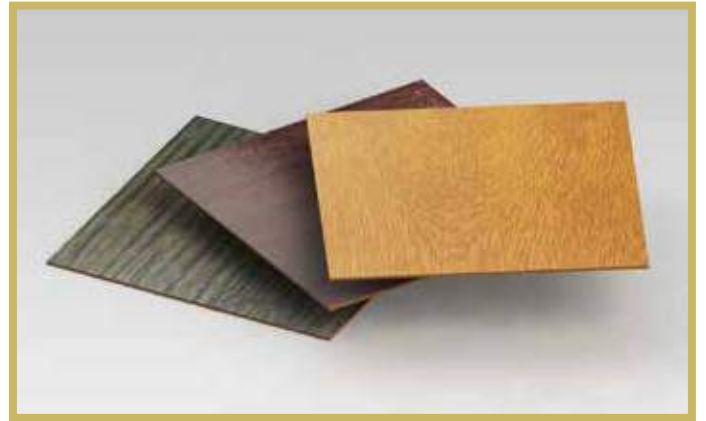

**1994** > PVC Pencere ve Kapı Sistemleri imalat ve montajı için Küçük Sanayi Sitesinde üretime başlamıştır.

**2002** > Artan talebi karşılamak amacıyla Organize Sanayi Bölgesinde alınan yeni fabrikasında Alman Teknolojisi ve Türk İşçisiyle Kendinden Gri Contalı PVC Profil üretimine geçmiştir. Kaliteli üretimi kendine amaç edinmiş ve kalitenin gereklilikleri olan TSE ve ISO belgeleriyle kalitesini kanıtlamıştır.

**2006** > Değişen Talepler Karşısında Sektörün Ahşap Desenli Profil ihtiyacını Karşılama amacıyla Altınmeşe ve Maun Görünümlü PVC Profil Üretimine geçmiştir.

**2009** > Makine parkurunu kurulduğu günden bu yana Krauss Maffei Marka Extruderler ile genişleten Eray Plastik Organize Sanayi Bölgesindeki Fabrika Üretim Tesisini 5000 m2 ye çıkarmış, kalitede sıfır hata prensibini belirlemiş ve bu sebeple hem Ar-Ge hem de sesini Avrupa'da duyurmak amacıyla Laboratuvarını genişletmiştir.

**2013** > Kendini sürekli yenileyen firma Fabrika Tesisini 10000 m2 kapalı alana çıkarmış, Makine parkuruna Krauss Maffei Marka 2 Extruder ve PVC Levha Hattı ile birlikte CNC işleme merkezi katmıştır.







# winTURK

PVC KAPI VE PENCERE SİSTEMLERİ



## Eraypen®

PVC KAPI ve PENCERE SİSTEMLERİ

[www.winturk.com.tr](http://www.winturk.com.tr)

### FABRİKA

Organize Sanayi Bölgesi  
8. Cadde No: 28 ESKİŞEHİR  
Tel: +90 222 236 14 91 (pbx)  
Fax: +90 222 236 14 95

### İSTANBUL BÖLGE MÜDÜRLÜĞÜ

İkitelli Org. San. Bölğ. Eskoop. San. Sit.  
C5 Blok No: 231 Başakşehir/İSTANBUL  
Tel: +90 212 549 71 93  
Fax: +90 212 549 71 94

### ZONGULDAK BÖLGE MÜDÜRLÜĞÜ

Yeşil Çaycuma Küçük San.Sit.  
C/2 Blok No: 23 Çaycuma/ZONGULDAK  
Tel: +90 372 615 32 02  
Fax: +90 372 615 32 02