

win **TURK**

PVC KAPI VE PENCERE SİSTEMLERİ

*Kalitesi ve
konforuyla
her mevsim
yanınızda...*



YENİ DİZAYN

Minaserisi
60'LİK 3 ODACIKLI SİSTEM

Miraserisi
60'LİK 4 ODACIKLI SİSTEM

Vegaserisi
70/60 5 ODACIKLI SİSTEM

Orionserisi
70'LİK 5 ODACIKLI SİSTEM

Atlasserisi
80'LİK 6 ODACIKLI SİSTEM

Sürmeserisi

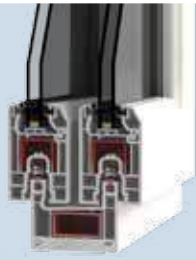
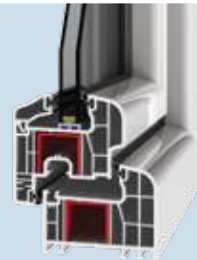
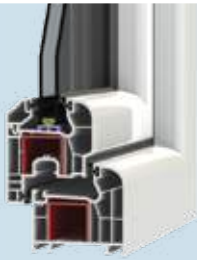



 Pvc kapı ve pencere sistemleri sektöründe faaliyet göstermek üzere 1994 yılında kurulan ERAY PLASTİK halen Eskişehir Organize Sanayi Bölgesinde 15.000 m² alan üzerinde **winTURK** markası ile üretimini devam ettirmektedir.

Firmamız dünya standartlarında yüksek kalite ve estetiğe sahip ürünlerini kendi ARGE çalışmalarıyla geliştirmiştir. Üretimde kullanılan hatlar, Avrupa'nın en iyileri kabul edilen Alman Krausmaffeı ve Avusturya Greinner PVC ekstrüzyon makinalarıdır.

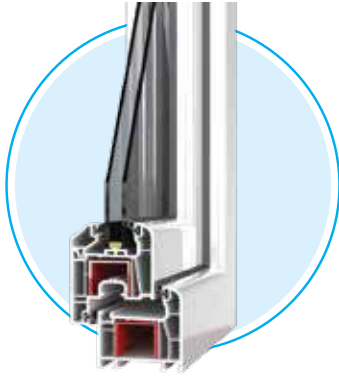
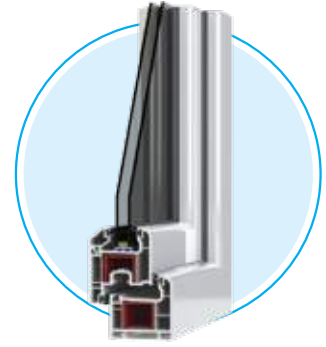

 ERAY PLASTİK, established in 1994 to perform business in PVC door and window systems industry, is currently continue its production on 15.000 m² area in Eskişehir Organized Industrial District with the brand name **winTURK**.

Our firm has developed its high quality and aesthetical products in world standards by its own research and development studies. The lines used in production are Krausmaffeı (German) and Greinner (Austria) PVC extrusion machines that have been recognized as the best of Europe.

winTURK

PVC Kapı ve Pencere Sistemleri her türlü mimari yapıya ve aksesuara uyum sağlayabilecek şekilde dizayn edilmiştir.





Modern yaşam alanları için dizayn edilmiş, ses ve ısı yalıtımı sağlayan

Minaserisi
60'LİK 3 ODACIKLI SİSTEM

Miraserisi
60'LİK 4 ODACIKLI SİSTEM

Vegaserisi
70/60 5 ODACIKLI SİSTEM

Orionserisi
70'LİK 5 ODACIKLI SİSTEM

Atlasserisi
80'LİK 6 ODACIKLI SİSTEM

Sürmeseri

- › Toz ve kir tutmayı önleyen, estetik görünüm sağlayan oval yüzey
- › Su tahliyesi sağlayan eğimli yüzey
- › Kendinden gri contalı profiller
- › Parlak ve pürüzsüz yüzeyler
- › Tek tırnak çıta yuvası ile kolay cam montajı
- › Kendinden contalı dekoratif çitalar
- › 4 mm tek cam , 4+12+4=20 mm, 4+12+4=24 mm çift cam ve 4+9+4+9+4=30 mm, 4+10+4+10+4=32 mm üç cam uygulama seçenekleri
- › Yüksek mukavemetli, sıcak daldırma, galvanizli tek tip çelik destek sacı
- › Ahşap desenli renk seçenekleri
- › Uzun ömürlü ve her türlü iklim şartına uyumlu

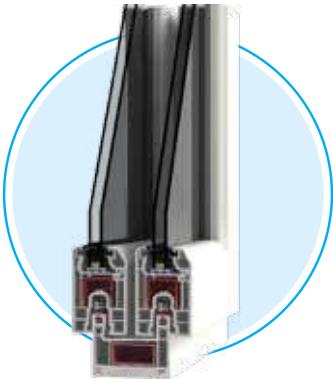
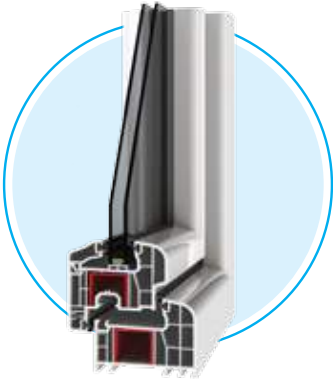
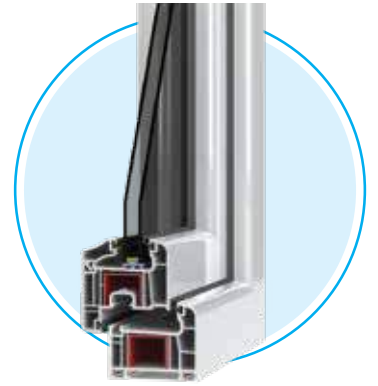
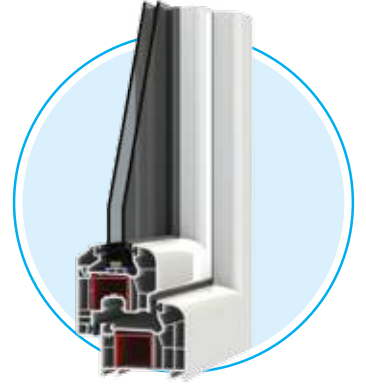

Systems designed for modern living spaces, sound and heat insulation

Minaserisi
60'LİK 3 ODACIKLI SİSTEM

Miraserisi
60'LİK 4 ODACIKLI SİSTEM

Vegaserisi
70/60 5 ODACIKLI SİSTEM

Orionserisi
70'LİK 5 ODACIKLI SİSTEM

Atlasserisi
80'LİK 6 ODACIKLI SİSTEM

Sürmeseri

- › To keep dust and dirt, preventing the oval surface that provides an aesthetic appearance
- › Sloping surface that allows water drainage
- › Profiles with gray seal
- › Bright and smooth surfaces
- › Easy fit glass with one leg glass bead
- › Decorative glass bead with gaskets seal
- › 4 mm single glass, 4 +12 +4 = 20 mm, 4 +12 +4 = 24 mm double glazing and 4 +9 +4 +9 +4 = 30 mm, 4 +10 +4 +10 +4 = 32 mm three glass application options
- › High strength, hot dipping, galvanized one type steel support plate
- › Laminated color options
- › Long-lasting and compatible with all kinds of weather condition



Miraserisi

60'LIK 4 ODACIKLI SİSTEM

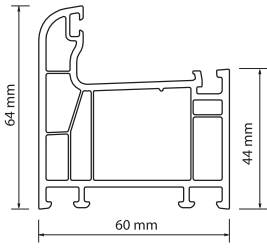

W 6410

Kasa Profili / Frame Profile
Ağırlık / Weight : 0.970 kg / mt

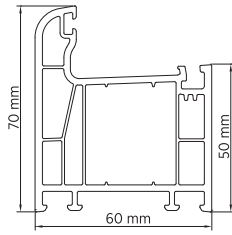

W 6410 S

Süper Kasa Profili
Super Frame Profile
Ağırlık / Weight : 1.110 kg / mt

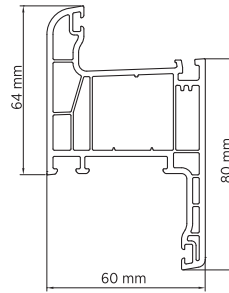

W 6410 P

Pervazlı Kasa Profili
Border Frame Profile
Ağırlık / Weight : 1.260 kg / mt

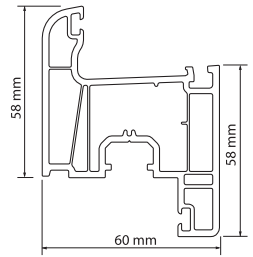

W 6420

Kanat Profili / Sash Profile
Ağırlık / Weight : 1.130 kg / mt

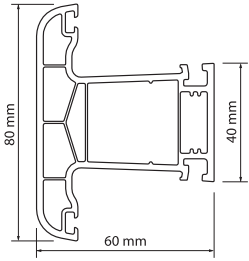

W 6430

Orta Kayıt Profili
Mullion Profile
Ağırlık / Weight : 1.050 kg / mt

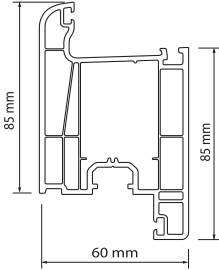

W 6440

Kapı Kanat Profili
Door Sash Profile
Ağırlık / Weight : 1.450 kg / mt

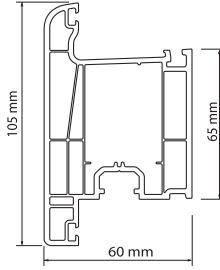

W 6450

Dışa Açılan Kapı Kanat Profili
Reverse Door Sash Profile
Ağırlık / Weight : 1.450 kg / mt

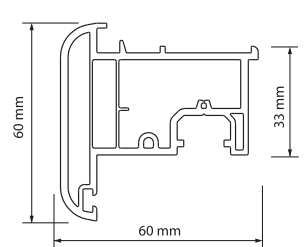

W 6460

Hareketli Orta Kayıt Profili
Moveable Mullion Profile
Ağırlık / Weight : 0.925 kg / mt

Minaserisi

60'LIK 3 ODACIKLI SİSTEM

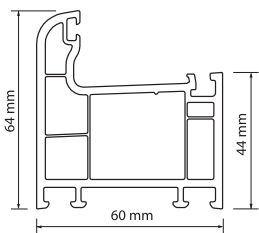

W 6310

Kasa Profili / Frame Profile
Ağırlık / Weight : 0.900 kg / mt

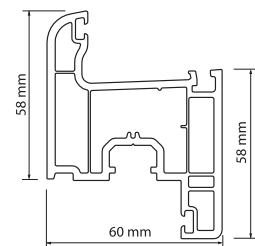

W 6320

Kanat Profili / Sash Profile
Ağırlık / Weight : 1.050 kg / mt

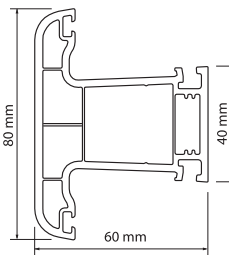

W 6330

Orta Kayıt Profili / Mullion Profile
Ağırlık / Weight : 0.950 kg / mt

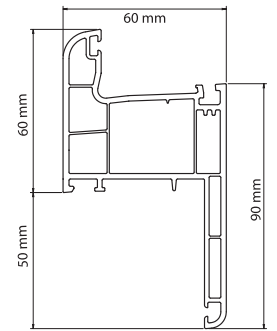

W 6310P

Pervazlı Kasa Profili
Border Frame Profile
Ağırlık / Weight : 1.260 kg / mt

Ortak Çıtalar

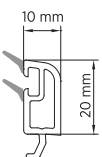

S 006

Üç Cam Çıtası (30 mm)
Three Glass Bead (30 mm)
Ağırlık / Weight : 0.185 kg / mt

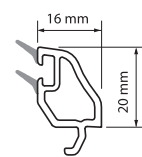

W 6470

Çift Cam Çıtası (24 mm)
Double Glass Bead (24 mm)
Ağırlık / Weight : 0.190 kg / mt

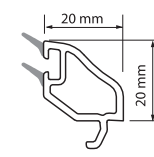

W 6480

Çift Cam Çıtası (20 mm)
Double Glass Bead (20 mm)
Ağırlık / Weight : 0.200 kg / mt

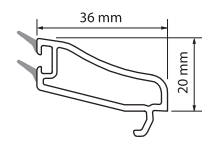

W 6490

Tek Cam Çıtası (4 mm)
Single Glass Bead (4 mm)
Ağırlık / Weight : 0.270 kg / mt

Orionserisi

70'LİK 5 ODACIKLI SİSTEM

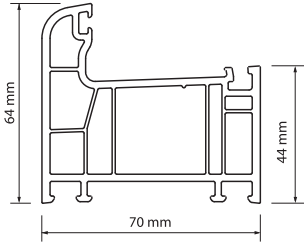

W 7010
Kasa Profili / Frame Profile
Ağırlık / Weight: 1.160 kg / mt

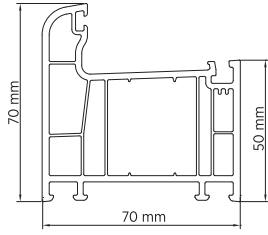

W 7010 S
Süper Kasa Profili
Super Frame Profile
Ağırlık / Weight: 1.230 kg / mt

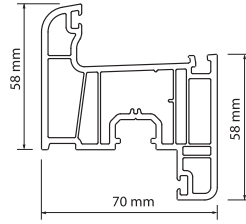

W 7020
Kanat Profili / Sash Profile
Ağırlık / Weight: 1.300 kg / mt

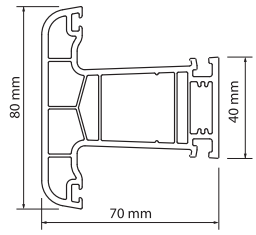

W 7030
Orta Kayıt Profili
Mullion Profile
Ağırlık / Weight: 1.250 kg / mt

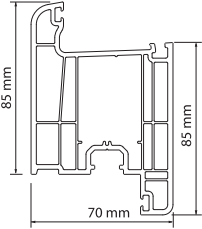

W 7040
Kapı Kanat Profili
Door Sash Profile
Ağırlık / Weight: 1.700 kg / mt

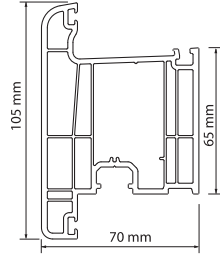

W 7050
Dışa Açılan Kapı Kanat Profili
Reverse Door Sash
Ağırlık / Weight: 1.700 kg / mt

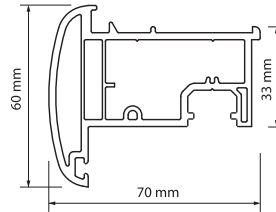

W 7060
Hareketli Orta Kayıt Profili
Moveable Mullion Profile
Ağırlık / Weight: 0.980 kg / mt

Atlasserisi

80'LİK 6 ODACIKLI SİSTEM

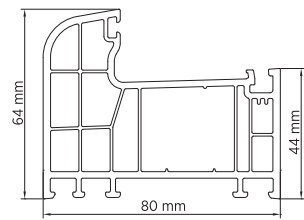

W 8010
Kasa Profili / Frame Profile
Ağırlık / Weight: 1.310 kg / mt

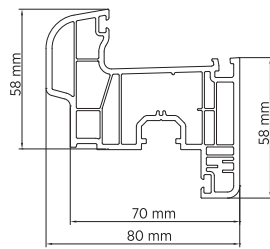

W 8020
Damlalıklı Kanat Profili
Self Drainage Sash Profile
Ağırlık / Weight: 1.400 kg / mt

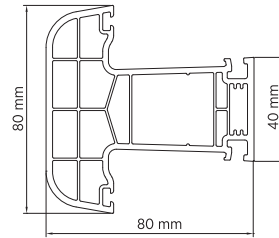

W 8030
Orta Kayıt Profili / Mullion Profile
Ağırlık / Weight: 1.420 kg / mt

Ortak Çıtalar

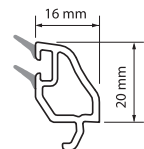

W 6470
Üç Cam Çıtası (32 mm)
Three Glass Bead (32 mm)
Ağırlık / Weight: 0.180 kg / mt

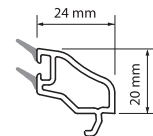

W 7070
Çift Cam Çıtası (24 mm)
Double Glass Bead (24 mm)
Ağırlık / Weight: 0.225 kg / mt

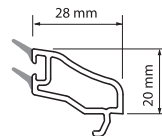

W 7080
Çift Cam Çıtası (20 mm)
Double Glass Bead (20 mm)
Ağırlık / Weight: 0.240 kg / mt

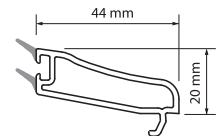

W 7090
Tek Cam Çıtası (4 mm)
Single Glass Bead (4 mm)
Ağırlık / Weight: 0.310 kg / mt

Vegāserisi
70/60 5 ODACIKLI SİSTEM

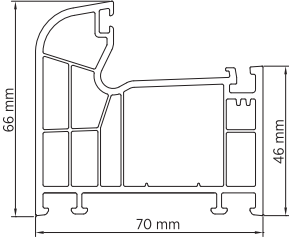

V 7610

Kasa Profili / Frame Profile
Ağırlık / Weight: 1.100 kg / mt

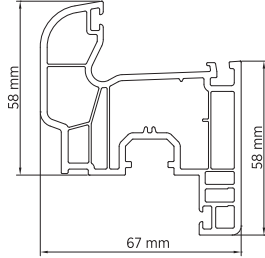

V 7620

Damlalıklı Kanat Profili
Self Drainage Sash Profile
Ağırlık / Weight: 1.170 kg / mt

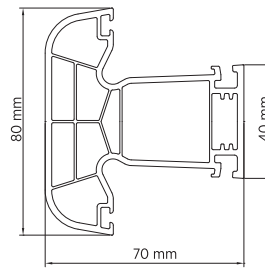

V 7630

Orta Kayıt Profili
Mullion Profile
Ağırlık / Weight: 1.250 kg / mt

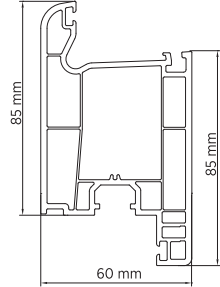

V 6440

Kapı Kanat Profili
Door Sash Profile
Ağırlık / Weight: 1.430 kg / mt

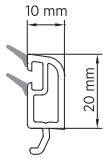

S 006

Üç Cam Çıtası (30 mm)
Three Glass Bead (30 mm)
Ağırlık / Weight: 0.185 kg / mt

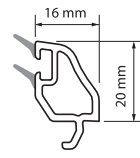

W 6470

Çift Cam Çıtası (24 mm)
Double Glass Bead (24 mm)
Ağırlık / Weight: 0.190 kg / mt

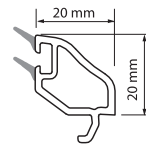

W 6480

Çift Cam Çıtası (20 mm)
Double Glass Bead (20 mm)
Ağırlık / Weight: 0.200 kg / mt

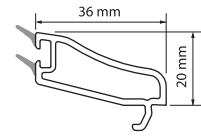

W 6490

Tek Cam Çıtası (4 mm)
Single Glass Bead (4 mm)
Ağırlık / Weight: 0.270 kg / mt

Sürme serisi

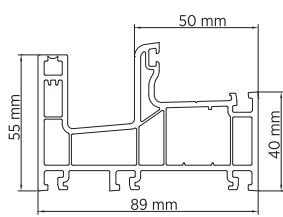

S 001

Sürme Tek Raylı Kasa
Fixed Sliding Door Frame Profile
Ağırlık / Weight: 1.470 kg / mt

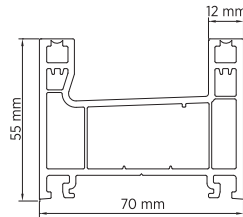

S 002

Sürme Çift Raylı Kasa
Fixed Sliding Door Frame Profile
Ağırlık / Weight: 1.150 kg / mt

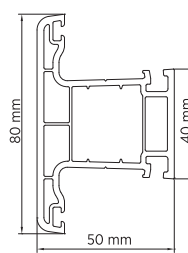

S 003

Sürme Orta Kayıt Profili
Sliding Mullion Profile
Ağırlık / Weight: 1.010 kg / mt

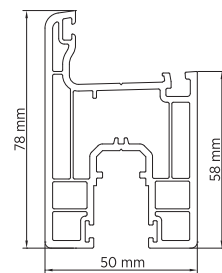

S 004

Sürme Kanat
Sliding Sash Profile
Ağırlık / Weight: 1.240 kg / mt

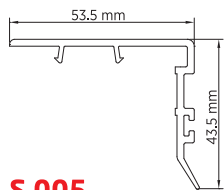

S 005

Sürme Kanat Kapama
Sliding Door Sash Profile
Ağırlık / Weight: 0.320 kg / mt

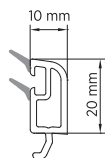

S 006

Sürme Çift Cam Çıtası (24 mm)
Sliding Double Glass Bead (24 mm)
Ağırlık / Weight: 0.183 kg / mt

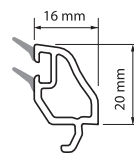

W 6470

Çift Cam Çıtası (18-20 mm)
Double Glass Bead (18-20 mm)
Ağırlık / Weight: 0.186 kg / mt

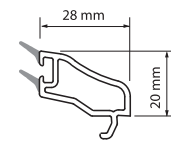

W 7080

Tek Cam Çıtası (4 mm)
Single Glass Bead (4 mm)
Ağırlık / Weight: 0.240 kg / mt

Yardımcı Profiller

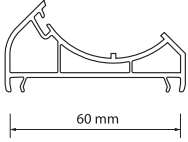

W 6520
60 mm Köşe Dönüş Adaptörü
60 mm Corner Turning Adapter
Ağırlık / Weight : 0.520 kg / mt

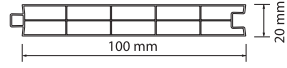

W 6530
100 mm Panel Profili
100 mm Panel Profile
Ağırlık / Weight : 0.560 kg / mt

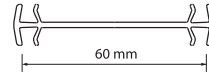

W 6540
60 mm İnce Bağ Profili
60 mm Coupling Profile
Ağırlık / Weight : 0.265 kg / mt

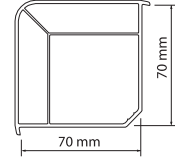

W 7100
70x70 Kutu Profili
70x70 Corner Profile
Ağırlık / Weight : 0.980 kg / mt

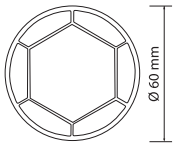

W 7110
Köşe Dönüş Borusu
Corner Turning Pipe
Ağırlık / Weight : 0.745 kg / mt

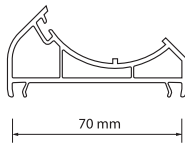

W 7120
70 mm Köşe Dönüş Adaptörü
70 mm Corner Turning Adapter
Ağırlık / Weight : 0.605 kg / mt

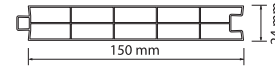

W 7130
150 mm Panel Profili
150 mm Panel Profile
Ağırlık / Weight : 0.790 kg / mt

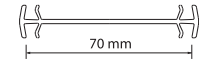

W 7140
70 mm İnce Bağ Profili
70 mm Coupling Profile
Ağırlık / Weight : 0.295 kg / mt

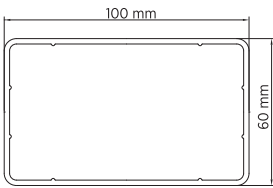

W 9010
100 x 60 Kutu Profili
100x60 Corner Profile
Ağırlık / Weight : 0.990 kg / mt

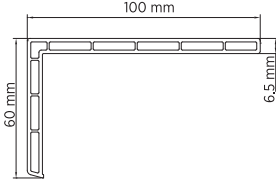

W 9020
Pervaz Profili
Sill Joint Extension Profile
Ağırlık / Weight : 0.720 kg / mt

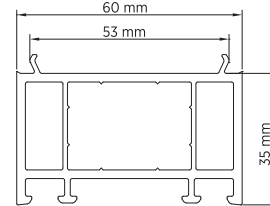

W 9060
60 mm Kasa Yükseltme Profili
60 mm Frame Extension Profile
Ağırlık / Weight : 0.760 kg / mt

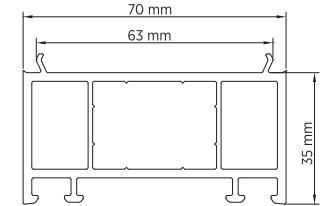

W 9070
70 mm Kasa Yükseltme Profili
70 mm Frame Extension Profile
Ağırlık / Weight : 0.830 kg / mt

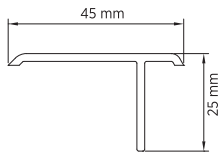

W 9040
T Kapama
Asymmetrical T
Ağırlık / Weight : 0.200 kg / mt

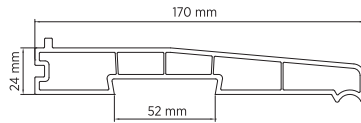

W 9000
Denizlik Profili
Outer Sill Profile
Ağırlık / Weight : 1.450 kg / mt

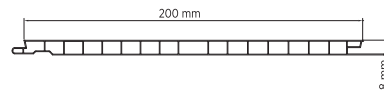

W 9030
Tavan Lambri
Flat PVC Panel
Ağırlık / Weight : 0.370 kg / mt

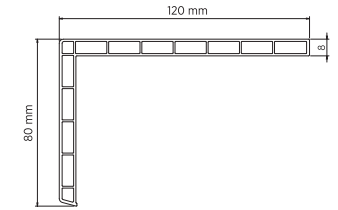

W 9050
Pervaz Profili
Sill Joint Extension Profile
Ağırlık / Weight : 0.820 kg / mt



Alyaserisi

60'LIK 4 ODACIKLI SİSTEM

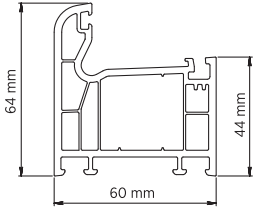

V 6610

Kasa Profili

Frame Profile

Ağırlık / Weight : 1.110 kg / mt

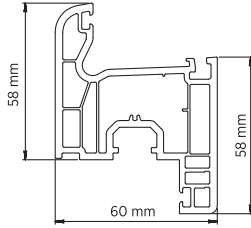

V 6620

Kanat Profili

Sash Profile

Ağırlık / Weight : 1.280 kg / mt

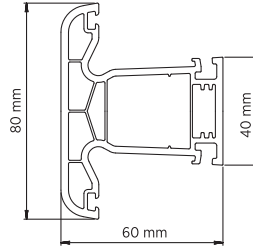

V 6630

Orta Kayıt Profili

Mullion Profile

Ağırlık / Weight : 1.220 kg / mt

Alternatif Çıtalar

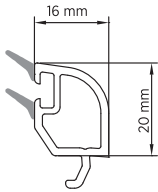

V 6470

Çift Cam Çıtası (24 mm)

Double Glass Bead (24 mm)

Ağırlık / Weight : 0.180 kg / mt

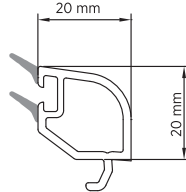

V 6480

Çift Cam Çıtası (20 mm)

Double Glass Bead (20 mm)

Ağırlık / Weight : 0.190 kg / mt

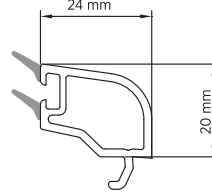

V 7070

Çift Cam Çıtası (24 mm)

Double Glass Bead (24 mm)

Ağırlık / Weight : 0.210 kg / mt

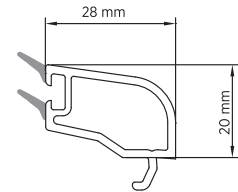

V 7080

Çift Cam Çıtası (20 mm)

Double Glass Bead (20 mm)

Ağırlık / Weight : 0.220 kg / mt

Destek Sac Detayları

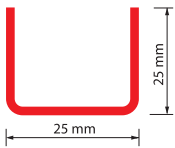

DS 001

Kasa / Kanat / Orta Kayıt
Destek Sacı

Frame / Sash / Mullion Steel

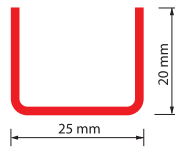

DS 002

Sürme Çiftli Kasa
Destek Sacı

Sliding Double Frame
Steel

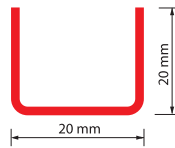

DS 003

Sürme Tekli Kasa
Destek Sacı

Sliding Single Frame
Steel

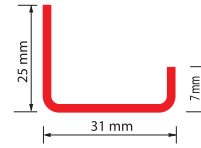

DS 004

Kanat Özel Sacı

Sash Special Steel

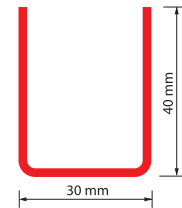

DS 005

Kapı / Dışa Açılan
Kapı Sacı

Door / Reverse Door Steel

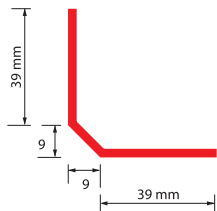

DS 006

70 x 70 Kutu Sacı

70 x 70 Corner Steel

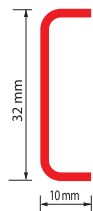

DS 007

60 mm Hareketli Orta Kayıt Sacı

60 mm Moveable Mullion Steel

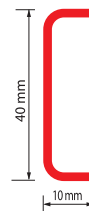

DS 008

70 mm Hareketli Orta Kayıt Sacı

70 mm Moveable Mullion Steel

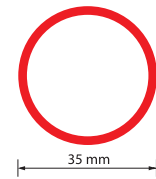

DS 009

Köşe Dönüş Boru Sacı

Corner Turning Pipe Steel

 Kuruluşundan itibaren kaliteli üretim politikasını belirleyen firmamız tercih ettiği hammaddelerle, TSE ve ISO 9001 sistemlerine uygun üretim yapmaktadır.

Çağdaş teknoloji ile Türk Mühendis ve işçiliğini birleştirerek kalıcı müşteri memnuniyetini sağlamak temel ilkemizdir.

winTURK olarak gerek üretim aşamasında gerek satış ve pazarlama aşamalarında hizmeti ticari kaygıların üstünde tutmaktadır.



Açtığımız pencerenin size huzur getirmesi dileği ile...



 Determining quality production policy since the establishment and by preferring raw materials, our firm make productions appropriate to TSE and ISO 9001 systems.

Our primary principle is to provide permanent client satisfaction by combining Turkish engineer and workforce with modern technology.

As **winTURK**, the service comes in front of our trading concerns in both production and sales and marketing stages.



Lamine Kaplama



 **winTURK** fabrika stoğunda katalogta görünen lamine kaplama çeşitlerini sürekli bulundurmaktadır. Lamine kaplamalar bütün serilerde uygulanmaktadır.



You can find at the catalogue the types of lamine, to be found in **winTURK** store everytime. These lamine plates are used in all series of our company.

altın meşe



maun



koyu meşe



Lamine Kaplama



Lamine Kaplama Örneklerimiz

altın meşe



maun

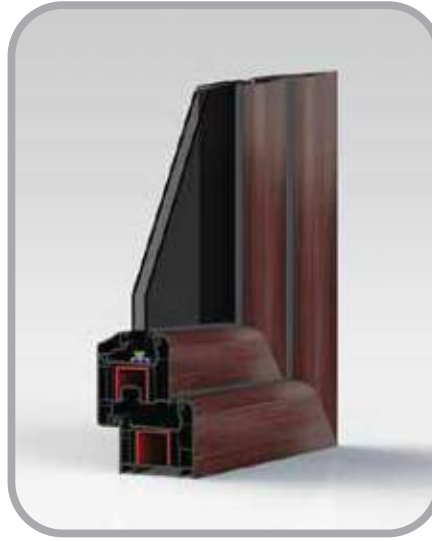

koyu meşe



Pencerelerinize ahşabın değerini ve güzelliğini katmak için...

- Zengin renk seçenekleri sayesinde dekorasyonunuza uygun,
- Ahşap görünümü sayesinde doğa dostu,
- Ahşap doğramalar gibi bakım ve boya gerektirmez.



Garantilidir
Guaranteed



Yeşili ve Çevreyi Korur
Protects Green and Environment

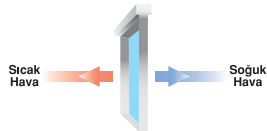

Sıcak ve Soğuk Havalara Dayanıklı
Resistant to Hot and Cold Weathers



%100 Yeniden Dönüşümlü
100% Recycled



Zehirli Madde İçermez
Does not contain any poisonous materials



Bakım ve Boya Gerektirmez
No need for Care and Painting

Sandwich Panel

SANDWICH PANEL

- Montajı kolay,
- Mukavemeti yüksek,
- Altınmeşe ve maun folyo ile kaplanabilir,
- Hafif olması sebebiyle taşınması ve nakliyesi kolaydır.
- UV dayanımı yüksek olduğu için uzun ömürlüdür.
- Ses ve ısı izolasyonu sağlar.
- Geri dönüşümlüdür.

Sandwich Panel Örnekleri

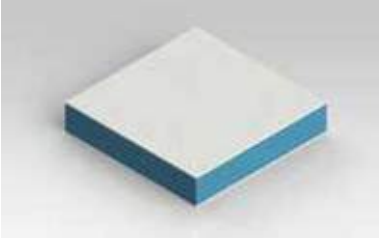

P 1020
BEYAZ SANDWICH PANEL (20 mm)
WHITE SANDWICH PANEL (20 mm)

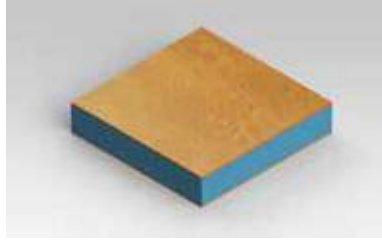

P 1020CA
ALTINMEŞE SANDWICH PANEL (20 mm)
GOLDENOAK SANDWICH PANEL (20 mm)

P 1024
BEYAZ SANDWICH PANEL (24 mm)
WHITE SANDWICH PANEL (24 mm)

P 1024CA
ALTINMEŞE SANDWICH PANEL (24 mm)
GOLDENOAK SANDWICH PANEL (24 mm)

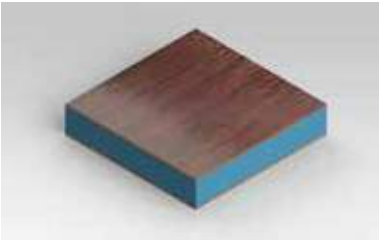

P 1020CM
MAUN SANDWICH PANEL (20 mm)
MAUN SANDWICH PANEL (20 mm)

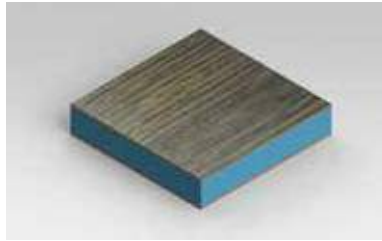

P 1020CK
KOYU MEŞE SANDWICH PANEL (20 mm)
DARKOAK SANDWICH PANEL (20 mm)

P 1024CM
MAUN SANDWICH PANEL (24 mm)
MAUN SANDWICH PANEL (24 mm)

P 1024CK
KOYU MEŞE SANDWICH PANEL (24 mm)
DARKOAK SANDWICH PANEL (24 mm)



PVC Levha



PVC esaslı levhalar 0,70 mm'den 3,00 mm kalınlığa ve 500 mm'den 2000 mm genişliğe kadar üretilmektedir.

- Yüksek UV dayanımı vardır.
- Darbe direnci yüksektir.
- Suya karşı dayanıklıdır.
- Isı iletkenliği düşüktür.
- Isı izolasyonu yüksektir.
- Ses izolasyonu yüksektir.
- Thermoform sayesinde çok basit şekillendirilebilir.

Genel olarak Sandwich Panel yapımında, PVC kapılarda ve hijyen gerektiren gıda sektöründe kaplama malzemesi olarak kullanılmaktadır.

Kaplamalı levhalarda

- *Altınmeşe*
- *Maun*
- *Koyumeşe*

Uygulamamız mevcuttur.

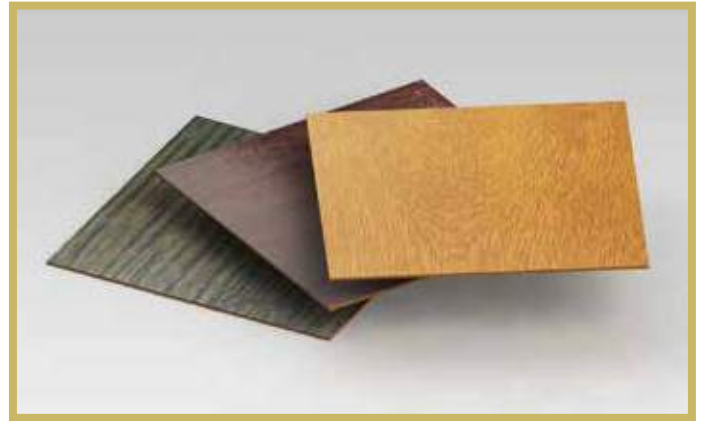

1994 > PVC Pencere ve Kapı Sistemleri imalat ve montajı için Küçük Sanayi Sitesinde üretime başlamıştır.

2002 > Artan talebi karşılamak amacıyla Organize Sanayi Bölgesinde alınan yeni fabrikasında Alman Teknolojisi ve Türk İşçisiyle Kendinden Gri Contalı PVC Profil üretimine geçmiştir. Kaliteli üretimi kendine amaç edinmiş ve kalitenin gereklilikleri olan TSE ve ISO belgeleriyle kalitesini kanıtlamıştır.

2006 > Değişen Talepler Karşısında Sektörün Ahşap Desenli Profil ihtiyacını Karşılama amacıyla Altınmeşe ve Maun Görünümlü PVC Profil Üretimine geçmiştir.

2009 > Makine parkurunu kurulduğu günden bu yana Krauss Maffei Marka Extruderler ile genişleten Eray Plastik Organize Sanayi Bölgesindeki Fabrika Üretim Tesisini 5000 m2 ye çıkarmış, kalitede sıfır hata prensibini belirlemiş ve bu sebeple hem Ar-Ge hem de sesini Avrupa'da duyurmak amacıyla Laboratuvarını genişletmiştir.

2013 > Kendini sürekli yenileyen firma Fabrika Tesisini 10000 m2 kapalı alana çıkarmış, Makine parkuruna Krauss Maffei Marka 2 Extruder ve PVC Levha Hattı ile birlikte CNC işleme merkezi katmıştır.







winTURK

PVC KAPI VE PENCERE SİSTEMLERİ



Eraypen®

PVC KAPI ve PENCERE SİSTEMLERİ

www.winturk.com.tr

FABRİKA

Organize Sanayi Bölgesi
8. Cadde No: 28 ESKİŞEHİR
Tel: +90 222 236 14 91 (pbx)
Fax: +90 222 236 14 95

İSTANBUL BÖLGE MÜDÜRLÜĞÜ

İkitelli Org. San. Bölğ. Eskoop. San. Sit.
C5 Blok No: 231 Başakşehir/İSTANBUL
Tel: +90 212 549 71 93
Fax: +90 212 549 71 94

ZONGULDAK BÖLGE MÜDÜRLÜĞÜ

Yeşil Çaycuma Küçük San.Sit.
C/2 Blok No: 23 Çaycuma/ZONGULDAK
Tel: +90 372 615 32 02
Fax: +90 372 615 32 02